

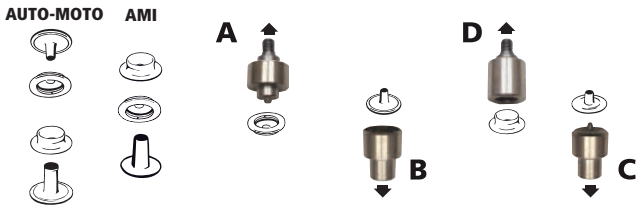

• Art. ▶ 83

▶ **ART. 12 KNOFLÍKY STISKACÍ NÝTOVACÍ NA SILNÉ LÁTKY**
ART. 12 SNAP FASTENERS FOR THICK MATERIAL



▶ **DĚROVADLO PUNCHING TOOL**

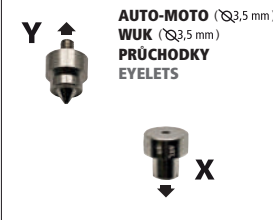

▶ **ART. 40 NÝT S POVLAKEM**
ART. 40 RIVET WITH COATING

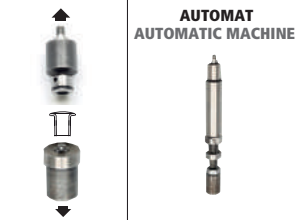

▶ **ART. 41 NÝT WOLF**
ART. 41 RIVET WOLF

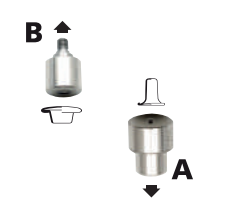

▶ **ART. 13 KNOFLÍKY STISKACÍ NÝTOVACÍ NA STŘEDNĚ SILNÉ LÁTKY**
ART. 13 SNAP FASTENERS FOR MIDDLE THICK MATERIAL

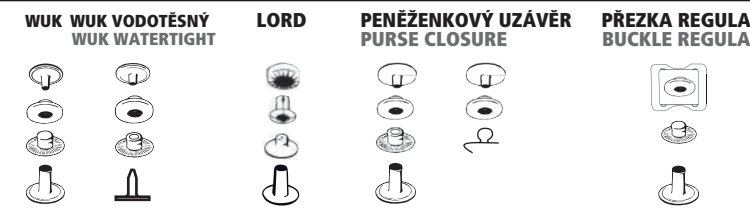

▶ **ART. W5 PRŮCHODKY**
ART. W5 EYELETS

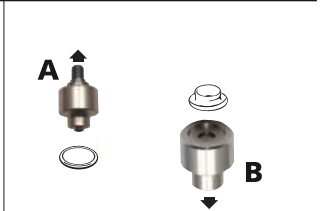

▶ **ART. 16 KNOFLÍKY STISKACÍ NÝTOVACÍ S HROTY NA SLABĚ LÁTKY**
ART. 16 SNAP FASTENERS FOR THIN MATERIAL

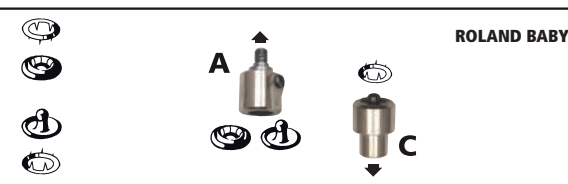

▶ **ART. 23 KNOFLÍKY PRO RUČNÍ POTAHOVÁNÍ**
ART. 23 BUTTONS SELF COVERED

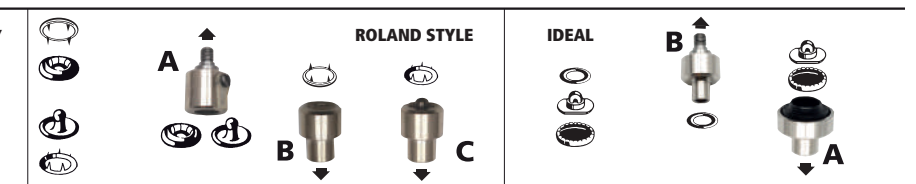

▶ **ART. 26 KNOFLÍKY ZAPÍNAČÍ NESNÍMATELNÉ JEANSOVÉ**
ART. 26 BUTTONS UNREMOVABLE JEANS

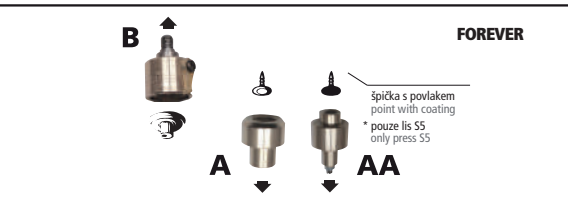

▶ **ART. 27 KNOFLÍKY ZAPÍNAČÍ SNÍMATELNÉ**
ART. 27 BUTTONS DETACHABLE

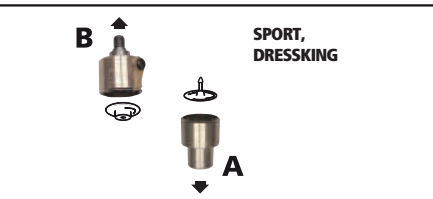

▶ **ART. 28 KALHOTOVÝ NÝT**
ART. 28 TROUSER RIVET

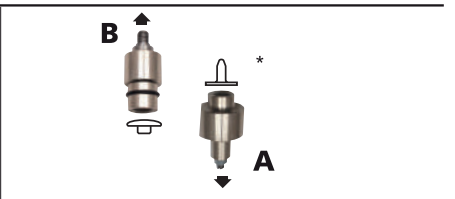

Provedení magnetické
Magnetic tools

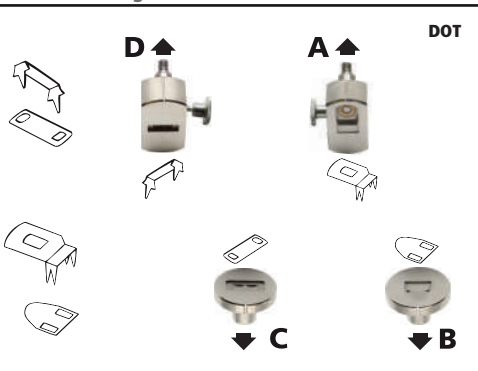

▶ **ART. 31 KALHOTOVÁ SPÍNADLA**
ART. 31 TROUSER HOOKS

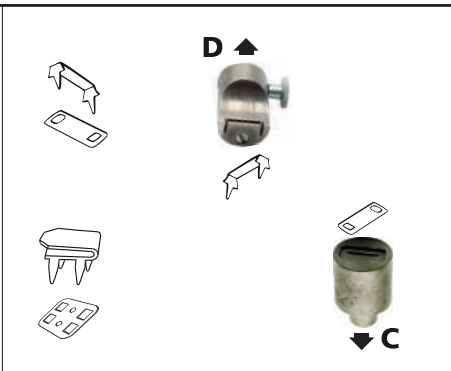

Provedení s výklopnou lištou
Tools with tipping lath

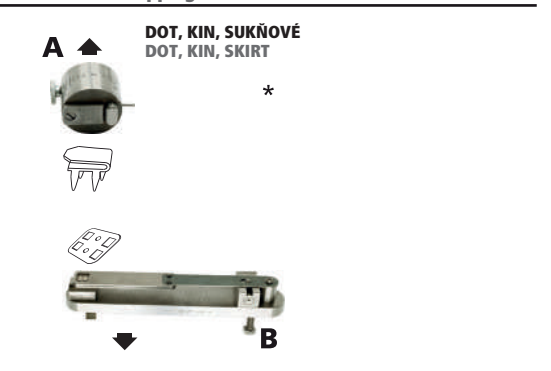

Upínací rozměry: horní píst - závit M6
spodní píst - čep Ø12,20 mm
Clamping dimensions: upper tool - thread M6
bottom tool - pivot Ø12,20 mm

* Pouze do ručního lisu S5 nebo lisu pneumatického
To be use only with hand press S5 or pneumatic press